

customer documents

FenOffice

software for window construction



customer documents

info

-  ***ProAdmin***
-  ***ProDesign***
-  ***ProView***
-  ***ProRepair***
-  ***ProService***

Step into the world of ProLogic

ProLogic
COMPUTER GMBH

The right choice for:

window manufacturers and dealers, carpentry companies, carpenters and office organisation.

Software
solutions
integrated
to fit



Contents

Quotation (1st example)	4
Quotation (2nd example)	8
Element in larger scale	11
Order confirmation	12
Positions in larger scale	15
Delivery note	16
Invoice	18
Outgoing invoice book	20
1st Reminder	21
Precalculation sheet	22
Precalculation sheet (detailed)	24
Precalculation sheet (totals)	28
Precalculation sheet (price list)	30
Material statistics (e.g. ALU)	31
Quantity evaluation	32

Rinderfelder Strasse 17
97270 Kist
GERMANY
www.prologic-kist.de



Mr. Walter C. Brown
49 Featherstone Street
LONDON
EC1Y 8SY
UNITED KINGDOM

QUOTATION

Windows - Doors - Accessories

of our own manufacturing

Process no.:	QU-05/006-010	Customer phone:	+44 23 / 928827-88	consisting of wood
Representative:	David Wilborough	Customer fax:	+44 23 / 928827-99	and wood-aluminium
				Insect protection solutions

Building project: Renovation and extension to the house

Portsmouth, 2006-03-05

Dear Mr Smith,

We thank you very much for the very friendly meeting and conversation. As requested we submit an offer to you as follows:

Design system: Wooden windows state-of-the-art. Glazing beads with covered mounting. The manufacturing is done at our own factory. System: **IV 67 Wooden windows with standard glazing profile**

Timber: **Pine laminated wood**, kiln-dried according to DIN standard





Varnishing: The surface-treatment is effectly done by dipping and spraying operations, including an intermediate grinding. Multi-layer coating as follows:
 Impregnation: **GORI 356.00200 Antistain and Impregnating agent**
 Priming coat: **GORI 411.64805 Natural-brown**
 Intermediate coat: **GORI 412.00112 Intermediate glaze**
 Finishing coat: **GORI 897.40310 Pine**, non-blocking

Glazing: Thermal insulated glazing with silicone sealing on both sides in transparent colour.
 Glass type: **Climaplus N (Air) Float 4mm / 16 / Futur 4mm**

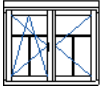
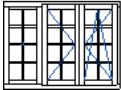

Gasket system: Special gasket consisting of high-quality materials. The profiles are characterised by long durability, temperature resistance and weathering resistance.
 Scheme: **Double gasket at sash** in the colour of **brown**

Fitting system: **ROTO NT window hardware in Security level 0 (basic)**, three-dimensional adjustable fittings with locking mechanisms concealed in the rebate; one handle operation. All locking points are made for the standard hardware groove of 16.3 mm width and 2.5 mm depth.
 Spring-loaded automatic locking pin compensates for rebate clearance deficiencies which sometimes occur - spring travel 1,2 mm; closing pressure of automatic pins adjustable with Torx.
 Clip connection of locking gear and stay arm connecting plate.
 Additional ventilation positions possible due to optional slit ventilation springs.
 Anti-bang security device in the stay arm.
 Appendant handle **RotoLine handle** in the colour of **R 01.2 newsilver**.

Delivery & Assembling: Underlying delivery mode: **to building site**; Execution of mounting : **New building**.

Pos	No	Drawing	Description of items	Unit price	Net total
1st phase of construction					
Regular windows					
1	3 Pieces	Scale 1:100 	Single-sash window T+T sash right, Affixed bar double-sided Width x Height: 900 mm x 1080 mm Interior window sill: Werzalit Exclusiv E 34/4 150mm (White marble) Exterior window sill: Guntia @ 40/25 130mm (Bronze G214)	770,00	2.310,00
2	1 Piece	Scale 1:100 	Double-sash window 2 sashes: T+T sash left (1) and Turning sash right (2), frame extension at the top, Affixed bar double-sided Width x Height: 1450 mm x 1280 mm Interior window sill: Werzalit Exclusiv E 34/4 150mm (White marble) Exterior window sill: Guntia @ 40/25 130mm (Bronze G214)	1.158,00	1.158,00
3	3 Pieces	Scale 1:100 	Double-sash window With mullion, 2 sashes: Turning sash left (2) and T+T sash right (1), 1 x fixed glazing, Affixed bar double-sided Width x Height: 1750 mm x 1340 mm Interior window sill: Werzalit Exclusiv E 34/4 150mm (White marble) Exterior window sill: Guntia @ 40/25 130mm (Bronze G214)	1.406,00	4.218,00
4	2 Pieces	Scale 1:100 	Single-sash window Chamfered window, Turning sash left, Glass-dividing bar Width x Height: 900 mm x 1320 mm Interior window sill: Werzalit Exclusiv E 34/4 150mm (White marble) Exterior window sill: Guntia @ 40/25 130mm (Bronze G214)	1.236,00	2.472,00
5	2 Pieces	Scale 1:100 	Single-sash window Chamfered window, Turning sash right, Glass-dividing bar Width x Height: 900 mm x 1320 mm Interior window sill: Werzalit Exclusiv E 34/4 150mm (White marble) Exterior window sill: Guntia @ 40/25 130mm (Bronze G214)	1.236,00	2.472,00
6	1 Piece	Scale 1:100 	Single-sash window Circular window with transom, Tilted sash, 1 x fixed glazing, Affixed bar double-sided Width x Height: 1150 mm x 1150 mm Interior window sill: Werzalit Exclusiv E 34/4 150mm (White marble) Exterior window sill: Guntia @ 40/25 130mm (Bronze G214)	1.929,00	1.929,00
Sub-total: 1st phase of construction					14.559,00

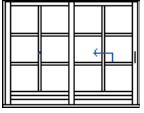
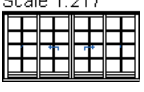
Windows - Doors - Accessories in wood and wood-aluminium
of our own manufacturing

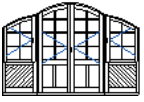
Pos	No	Drawing	Description of items	Unit price	Net total
2nd phase of construction					
Doors and elements					
(lift-slide, fold-slide, composite and special)					
7	2 Pieces	Scale 1:135 	Lift-slide element G-U 934 scheme A movable sash on the right, fixed sash on the left, with glass-dividing bars Width x Height: 2800 mm x 2250 mm Additional items: Strip 47 30x30mm and Strip 48 30x30mm Profile system: IV 67 Lifting-sliding elements Metal fittings: G-U Lift-Slide Serie 93x/95x Handle: Lever-handle DIRIGENT Timber type: Oak laminated wood Glass type: Climaplus N (Argon) Float 4mm / 16 / Futur 4mm Surface coating: GORI 897.11310 RAL 9016	1.900,00	3.800,00
8	1 Piece	Scale 1:217 	Lift-slide element G-U 934 scheme C 1st opening sash on the left Width x Height: 4500 mm x 2300 mm Additional items: Strip 47 30x30mm and Strip 48 30x30mm Profile system: IV 67 Lifting-sliding elements Metal fittings: G-U Lift-Slide Serie 93x/95x Handle: Lever-handle DIRIGENT Timber type: Oak laminated wood Glass type: Climaplus N (Argon) Float 4mm / 16 / Futur 4mm Surface coating: GORI 897.11310 RAL 9016	3.157,00	3.157,00
9	1 Piece	Scale 1:265 	Fold-slide element Patio 6080 scheme 541 5 sashes, with single turning sash right Width x Height: 5500 mm x 2300 mm Handle: RotoLine Flat-Handle (R07.2 white) Timber type: Oak laminated wood	3.843,00	3.843,00
10	1 Piece	Scale 1:125 	Front door left-turning with sandwich panel Width x Height: 1160 mm x 2078 mm Metal fittings: Front door fittings Handle: Security furnit. ES1 turn-turn (aluminium nature) Timber type: Oak laminated wood Surface coating: GORI 897.60110 Teak	924,00	924,00
11	1 Piece	Scale 1:174 	Window element <i>consisting of :</i> Pos.11a : Single-sash window Rounded arch window with transom, Turning sash left, Bars between panes Helima 26mm mahagoni-coloured, 1 x balustrade, Pos.11b : Double-sash French door Rounded arch window, 2 sashes with Turning sash left (2) and Turning sash right (1), Glass-dividing bar and Bars between panes Helima 26mm mahagoni-coloured and Pos.11c : Single-sash window Rounded arch window with transom, Turning sash right, Bars between panes Helima 26mm mahagoni-coloured, 1 x balustrade Width x Height: 3600 mm x 2450 mm	6.577,00	6.577,00

Windows - Doors - Accessories in wood and wood-aluminium
of our own manufacturing

Pos	No	Drawing	Description of items	Unit price	Net total
12	1 Piece	Scale 1:125 	Single-sash French door T+T sash right, Glass-dividing bar, 1 x Panel Width x Height: 1180 mm x 1980 mm	2.649,00	2.649,00
13	1 Piece	Scale 1:100 	Double-sash French window 2 sashes: T+T sash left (1) and Turning sash right (2), Affixed bar double-sided Width x Height: 1000 mm x 1280 mm Surface coating: Frame: GORI RAL colour (RAL 7039), Sash: GORI RAL colour (RAL 3016)	1.995,00	1.995,00

Sub-total: 2nd phase of construction 22.945,00

Additional services and accessories

14	6,50 m ²		Disassembling of window element	12,80	83,20
15	6,50 m ²		Waste disposal (old windows)	6,23	40,50
16	52,48 m		Joint caulking according to the state-of-the-art For position 1 - 9	5,54	290,73
17	52,48 m		RAL-Assembling of window elements according to the state-of-the-art, including all necessary materials For position 1 - 9	12,46	653,87

Sub-total: Additional services and accessories 1.068,30

Sum of positions:	38.572,30
Less 5,00 % Special discount::	1.895,92
Net total:	36.676,38
Plus 16,0 % VAT:	5.868,22
Gross total:	42.544,60

Please note: all prices are in the currency of GBP.

Payable during 3 days with discount of 5,0 %, payable during 8 days with discount of 2,0 %, otherwise payable during 30 days due net.

Place of delivery, payment and jurisdiction is the business location of Leda Engineering Ltd. The ordered items remain to property of our company until complete payment. The delivery will take place according to our General Business Provisions. Additional agreements are exclusively valid in writing.

We trust that you will find our quotation acceptable. If you have any further questions, I would be glad to be of help to you on phone no. +44 51 / 574839-12.

Yours faithfully

D. Wilborough
General Manager

Windows - Doors - Accessories in wood and wood-aluminium
of our own manufacturing

Rinderfelder Strasse 17
97270 Kist
GERMANY
www.prologic-kist.de



Mr. Walter C. Brown
49 Featherstone Street
LONDON
EC1Y 8SY
UNITED KINGDOM

QUOTATION

Windows - Doors - Accessories

of our own manufacturing

Process no.:	QU-05/006-010	Customer phone:	+44 23 / 928827-88	consisting of wood
Representative:	David Wilborough	Customer fax:	+44 23 / 928827-99	and wood-aluminium
				Insect protection solutions

Building project: Renovation and extension to the house

March 05, 2006

Dear Mr Smith,

We thank you very much for the very friendly meeting and conversation. As requested we submit an offer to you as follows:

Design system: **IV 67 Wooden windows with standard glazing profile**

Timber: **Pine laminated wood**

Varnishing: Priming coat: **GORI 411.64805 Natural-brown**
Intermediate coat: **GORI 412.00112 Intermediate glaze**
Finishing coat: **GORI 897.40310 Pine, non-blocking**

Glazing: Thermal insulated glazing with **Climaplust N (Air) Float 4mm / 16 / Futur 4mm**









Gasket system: **Double gasket at sash** in the colour of **brown**

Fitting system: **ROTO NT window hardware** in **Security level 0 (basic)**,
Appendant handle **RotoLine handle** in the colour of **R 01.2 newsilver**.

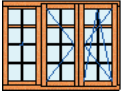

Window sills: Interior: **Weralit Exclusiv E 34/4 150mm (White marble)**
Exterior: **Guntia ® 40/25 130mm (Bronze G214)**

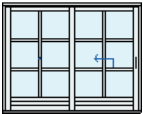
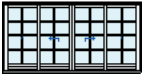
Delivery & Assembling: Underlying delivery mode: **to building site**; Execution of mounting : **New building**.

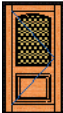
Sum of positions:	38.572,30 GBP
Less 5,00 % Special discount:	1.895,92 GBP
Net total:	36.676,38 GBP
Plus 16,0 % VAT:	5.868,22 GBP
Gross total:	42.544,60 GBP

Pos	No	Drawing	Description of items	Unit price	Net total
1st phase of construction					
regular windows					
1	3Piece	Scale 1:100 	Single-sash window T+T sash right, affixed bar double-sided Width x Height: 900 mm x 1080 mm	770,00 GBP	2.310,00 GBP
2	1Piece	Scale 1:100 	Double-sash window with frame extension top, T+T sash left (1) and Turning sash right (2), Affixed bar double-sided Width x Height: 1450 mm x 1280 mm	1.158,00 GBP	1.158,00 GBP
3	3Piece	Scale 1:100 	Double-sash window with mullion, turning sash left (2) and T+T sash right (1), , 1 x fixed glazing, affixed bar double-sided Width x Height: 1750 mm x 1340 mm	1.406,00 GBP	4.218,00 GBP
4	2Piece	Scale 1:100 	Chamfered single-sash window turning sash left, glass-dividing bar Width x Height: 900 mm x 1320 mm	1.236,00 GBP	2.472,00 GBP
5	2Piece	Scale 1:100 	Chamfered single-sash window turning sash right, glass-dividing bar Width x Height: 900 mm x 1320 mm	1.236,00 GBP	2.472,00 GBP
6	1Piece	Scale 1:100 	Circular single-sash window with transom, tilted sash, affixed bar double-sided, 1 x fixed glazing Width x Height: 1150 mm x 1150 mm	1.929,00 GBP	1.929,00 GBP
Sub-total: 1st phase of construction					14.559,00 GBP
2nd phase of construction					
doors and elements (lift-slide, fold-slide, composite and special)					
7	2Piece	Scale 1:135 	Lift-slide element G-U 934 scheme A fixed sash on the left, glass-dividing bars Width x Height: 2800 mm x 2250 mm Timber type: Oak laminated wood Glass type: Climaplust N (Argon) 4/16/4 Surface coating: GORI 897.11310 RAL 9016	1.900,00 GBP	3.800,00 GBP
8	1Piece	Scale 1:217 	Lift-slide element G-U 934 scheme C 1st opening on the left Width x Height: 4500 mm x 2300 mm Timber type: Oak laminated wood Glass type: Climaplust N (Argon) 4/16/4 Surface coating: GORI 897.11310 RAL 9016	3.157,00 GBP	3.157,00 GBP
9	1Piece	Scale 1:265 	Fold-slide element Patio 6080 scheme 541 with single turning sash right Width x Height: 5500 mm x 2300 mm Metal fittings: ROTO Patio 6080 Fold&Slide Timber type: Oak laminated wood	3.843,00 GBP	3.843,00 GBP
10	1Piece	Scale 1:125 	Front door left-turning with sandwich panel Width x Height: 1160 mm x 2078 mm Timber type: Oak laminated wood Surface coating: GORI 897.60110 Teak	924,00 GBP	924,00 GBP

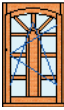
Windows - Doors - Accessories in wood and wood-aluminium
of our own manufacturing

Pos	Nc	Drawing	Description of items	Unit price	Net total
11	1Piece	Scale 1:174 	Window element consisting of : Pos.11a : Single-sash rounded arch window with transom, turning sash left, bars between panes Helima 26mm mahagoni-coloured, 1 x balustrade, Pos.11b : Double-sash French door rounded arch, turning sash left (2) and turning sash right (1), glass-dividing bar and bars between panes Helima 26mm mahagoni-coloured and Pos.11c : Single-sash rounded arch window with transom, turning sash right, bars between panes Helima 26mm mahagoni-coloured, 1 x balustrade Width x Height: 3600 mm x 2450 mm	6.577,00 GBP	6.577,00 GBP
12	1Piece	Scale 1:125 	Single-sash French door T+T sash right, glass-dividing bar Width x Height: 1180 mm x 1980 mm	2.649,00 GBP	2.649,00 GBP
13	1Piece	Scale 1:100 	Double-sash French window T+T sash left (1) and turning sash right (2), affixed bar double-sided Width x Height: 1000 mm x 1280 mm Surface coating: Frame: GORI RAL colour (RAL 7039), Sash: GORI RAL colour (RAL 3016)	1.995,00 GBP	1.995,00 GBP
Sub-total: 2nd phase of construction					22.945,00 GBP
Additional services and accessories					
14	6,50m ²		Disassembling of window element	12,80 GBP	83,20 GBP
15	6,50m ²		Waste disposal (old windows)	6,23 GBP	40,50 GBP
16	52,48m		Joint caulking according to the state-of-the-art For position 1 - 9	5,54 GBP	290,73 GBP
17	52,48m		RAL-Assembling of window elements according to the state-of-the-art, including all necessary materials For position 1 - 9	12,46 GBP	653,87 GBP
Sub-total: Additional services and accessories					1.068,30 GBP

Payable during 3 days with discount of 5,0 %, otherwise payable during 30 days due net.

We do hope that this information has been of help to you and we trust that you will find our quotation acceptable. If you require further details, please feel free to contact us.

Hoping to hear from you soon, I remain,

Yours faithfully

D. Wilborough
General Manager

Windows - Doors - Accessories in wood and wood-aluminium
of our own manufacturing

Element (composite drawing)

Elements Itemise

Number : 05/006

Client address : W.Brown 49 Featherstone Street UK-EC1Y 8SY London

PO commission : Victoria House B&B

Pos. 11

Quo. 2.10.205

1 Unit

Scale 1:25

4.3.2006 20:09

Page 1

ProLogic Computer GmbH EDP for window manufacturing

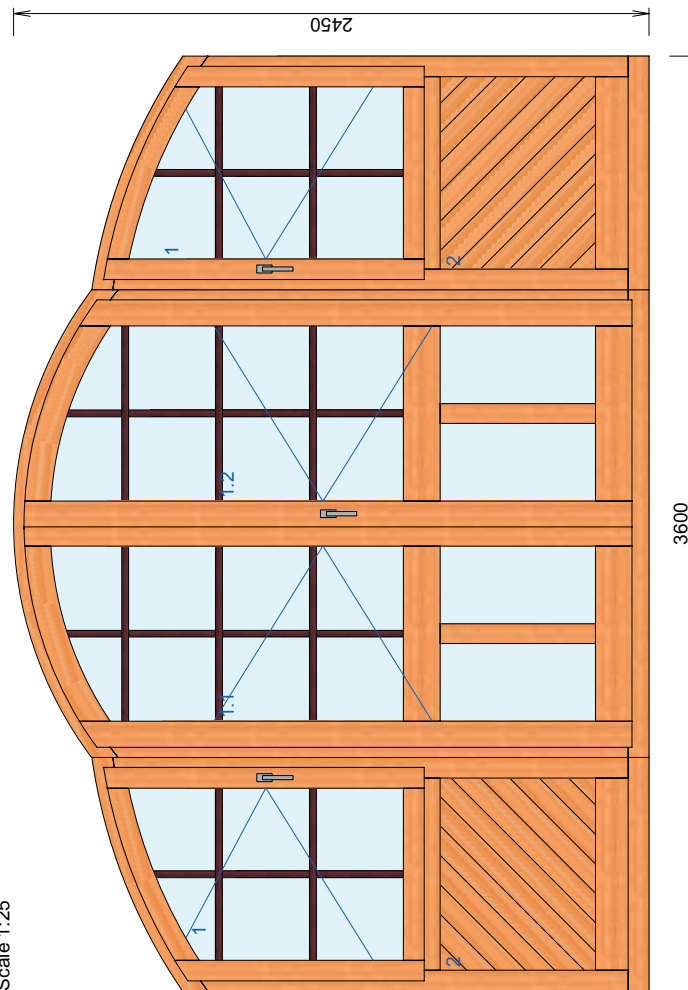

FenOffice 06 Professional (Build #183)

Copyright © 2005 by ProLogic Computer GmbH

Rinderfelder Strasse 17
97270 Kist
GERMANY
www.prologic-kist.de



Mr. Walter C. Brown
49 Featherstone Street
LONDON
EC1Y 8SY
UNITED KINGDOM

Windows - Doors - Accessories

ORDER CONFIRMATION

Process number : QU-05/006-010
PO commission : Victoria House B&B
Date of issue : 2006-03-06

Building project: Renovation and extension to the house

Delivery to the following address: **Victoria House B&B, 15 Hurn Street, BH23 6AA Christchurch**

Dear Mr Smith,

Thank you very much for your order. Herewith we are confirming the order as follows:

Design system: Wooden windows state-of-the-art. Glazing beads with covered mounting. The manufacturing is done at our own factory. System: **IV 67 Wooden windows with standard glazing profile**

Timber: **Pine laminated wood**, kiln-ried according to DIN standard

Varnishing: The surface-treatment is effectly done by dipping and spraying operations, including an intermediate grinding. Multi-layer coating as follows:
Impregnation: **GORI 356.00200 Antistain and Impregnating agent**
Priming coat: **GORI 411.64805 Natural-brown**
Intermediate coat: **GORI 412.00112 Intermediate glaze**
Finishing coat: **GORI 897.40310 Pine**, non-blocking

Glazing: Glazing with silicone sealing on both sides in transparent colour.
Glass type: **Climaplus N (Air) Float 4mm / 16 / Futur 4mm**

Gasket system: Special gasket consisting of high-quality materials. The profiles are characterised by long durability, temperature resistance and weathering resistance.
Scheme: **Double gasket at sash** in the colour of **brown**









Fitting system: **Metal fittings system** in **Security level 0 (basic)**, three-dimensional adjustable fittings with locking mechanisms concealed in the rebate; one handle operation. All locking points are made for the standard hardware groove of 16.3 mm width and 2.5 mm depth.
Spring-loaded automatic locking pin compensates for rebate clearance deficiencies which sometimes occur - spring travel 1,2 mm; closing pressure of automatic pins adjustable with Torx.
Clip connection of locking gear and stay arm connecting plate.
Additional ventilation positions possible due to optional slit ventilation springs.
Anti-bang security device in the stay arm.
Appendant handle **RotoLine handle** in the colour of **R 01.2 newsilver**.

Delivery & Assembling: Underlying delivery mode: **to building site**; Execution of mounting : **New building**.

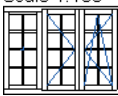
ORDER CONFIRMATION OC-05/006-004 to Mr. Walter C. Brown / Date of issue 2006-03-06 Page 2



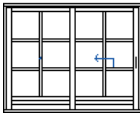
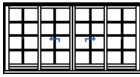

Sum of positions:	34.956,16 £
Less 5,00 % Special discount:	1.714,95 £
Net total:	33.241,21 £
Plus 16,0 % VAT:	5.318,59 £
Gross total:	38.559,80 £

Indication of price in EURO: 55.714,20 EUR

Pos	No	Drawing	Description of items	Unit price	Net total
1st phase of construction: regular windows					
1	3 Piece	Scale 1:100 	Single-sash window T+T sash right, Affixed bar double-sided Width x Height: 900 mm x 1180 mm	826,00 £	2.478,00 £
2	1 Piece	Scale 1:100 	Double-sash window Frame extension top, 2 sash T+T sash left (1) Turning sash right (2), Affixed bar double-sided Width x Height: 1450 mm x 1280 mm	1.109,00 £	1.109,00 £
3	3 Piece	Scale 1:100 	Double-sash window With mullion, Turning sash left (2) T+T sash right (1), Affixed bar double-sided, 1 x Fixed glazing Width x Height: 1750 mm x 1340 mm	1.457,00 £	4.371,00 £
4	2 Piece	Scale 1:100 	Single-sash window Chamfered window, Turning sash left, Glass-dividing bar Width x Height: 900 mm x 1320 mm	1.098,00 £	2.196,00 £
5	2 Piece	Scale 1:100 	Single-sash window Chamfered window, Turning sash right, Glass-dividing bar Width x Height: 900 mm x 1320 mm	1.098,00 £	2.196,00 £
6	1 Piece	Scale 1:100 	Single-sash window Circular window with transom, Tilted sash, Affixed bar double-sided, 1 x Fixed glazing Width x Height: 1150 mm x 1150 mm	1.649,00 £	1.649,00 £
2nd phase of construction: doors and elements					
7	2 Piece	Scale 1:135 	Lift-slide element G-U 934 scheme A Fixed sash on the left, Glass-dividing bars Width x Height: 2800 mm x 2250 mm Timber type: Oak laminated wood Glass type: Climaplust N (Argon) 4/16/4 Base coat: GORI 411.90870 Pine Surface coating: GORI 897.11310 RAL 9016	1.996,00 £	3.992,00 £
8	1 Piece	Scale 1:217 	Lift-slide element G-U 934 scheme C 1st opening sash on the left Width x Height: 4500 mm x 2300 mm Timber type: Oak laminated wood Glass type: Climaplust N (Argon) 4/16/4 Base coat: GORI 411.90870 Pine Surface coating: GORI 897.11310 RAL 9016	2.861,00 £	2.861,00 £
9	1 Piece	Scale 1:265 	Fold-slide element Patio 6080 scheme 541 Width x Height: 5500 mm x 2300 mm Timber type: Oak laminated wood	2.933,00 £	2.933,00 £

Windows - Doors - Accessories in wood and wood-aluminium

ORDER CONFIRMATION OC-05/006-004 to Mr. Walter C. Brown / Date of issue 2006-03-06 Page 3

Pos	No	Drawing	Description of items	Unit price	Net total
10	1 Piece	Scale 1:125 	Front door left-turning with sandwich panel Width x Height: 1160 mm x 2078 mm Timber type: Oak laminated wood Base coat: GORI 411.90870 Pine Surface coating: Frame: GORI 897.60110	939,00 £	939,00 £
11	1 Piece	Scale 1:174 	Window element <i>consisting of :</i> Pos.11a : Single-sash window Rounded arch window with Transom, Turning sash left, Bars between panes Helima 26mm mahagoni-coloured, 1 x balustrade, Pos.11b : Double-sash French door Rounded arch window, Turning sash left (2), Turning sash right (1), Glass-dividing bar and bars between panes Helima 26mm mahagoni-coloured and Pos.11c : Single-sash window Rounded arch window with transom, Turning sash right, Bars between panes Helima 26mm mahagoni-coloured, 1 x balustrade Width x Height: 3600 mm x 2450 mm	5.374,00 £	5.374,00 £
12	1 Piece	Scale 1:125 	Single-sash French door T+T sash right, Glass-dividing bar, Width x Height: 1180 mm x 1980 mm	2.094,00 £	2.094,00 £
13	1 Piece	Scale 1:100 	Double-sash French window T+T sash left (1), Turning sash right (2), Affixed bar double-sided Width x Height: 1000 mm x 1280 mm	1.691,00 £	1.691,00 £
Additional services and accessories					
14	6,50 m ²		Disassembling of window element	12,80 £	83,20 £
15	6,50 m ²		Waste disposal (old windows)	6,23 £	40,50 £
16	52,75 m		Joint caulking according to the state-of-the-art For position 1 - 9	5,54 £	292,22 £
17	52,75 m		RAL-Assembling of window elements according to the state-of-the-art, For position 1 - 9	12,46 £	657,24 £

Payable during 3 days with discount of 5,0 %, payable during 8 days with discount of 2,0 %, otherwise payable during 30 days due net.

Please check the particulars above and, if everything is correct, send back a signed copy of this document by fax on short notice to avoid any delay. Then we will invoice the prepayment and process your order immediately.

If you require further information, we would be glad to be of help to you. Many thanks in advance for processing at your earliest convenience.

Yours faithfully

D. Wilborough
General Manager

Windows - Doors - Accessories in wood and wood-aluminium

Drawing overview (feet / inch)

13.3.2006 12:51

Page 4

itemise

ProLogic Computer GmbH EDP for window manufacturing

Pos. 8
Quo. 2.10.202
1 Unit
Scale 1:27

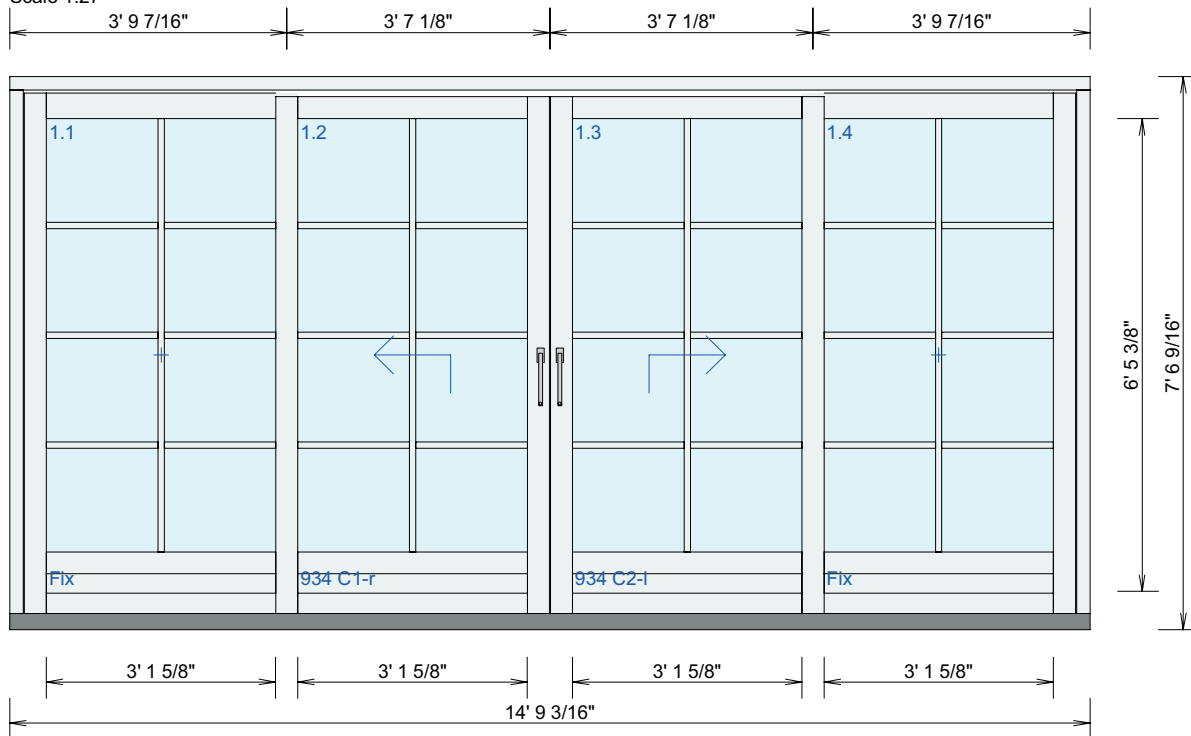

Pos. 9
Quo. 2.10.203
1 Unit
Scale 1:32

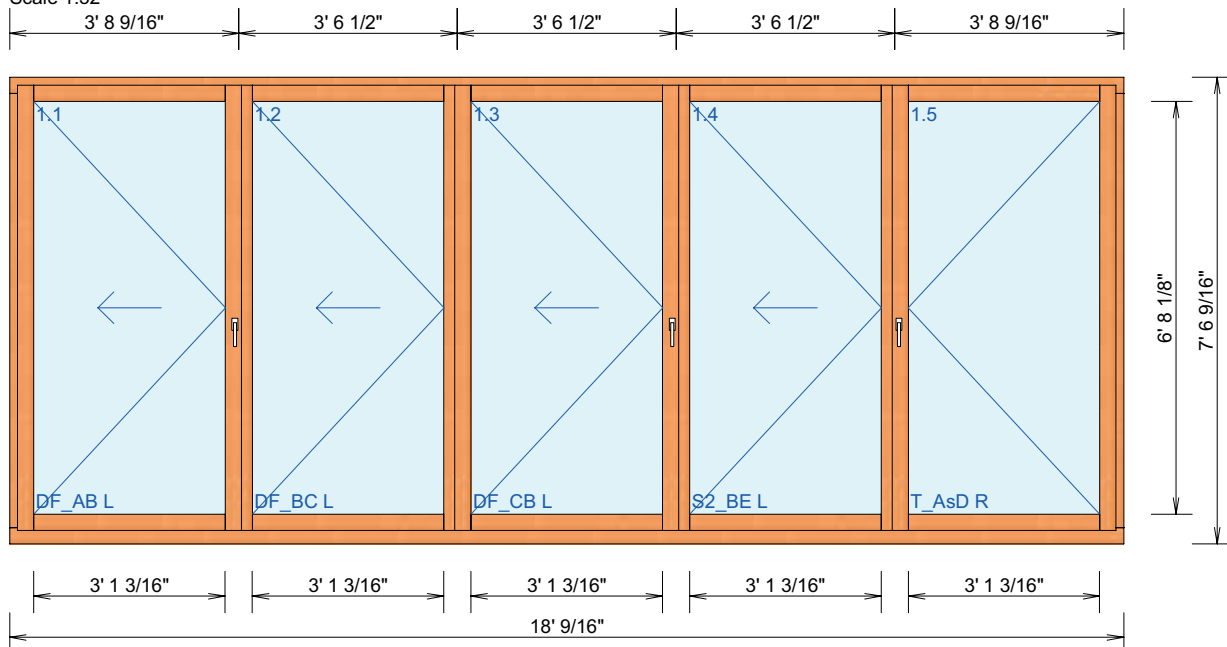

Rinderfelder Strasse 17
97270 Kist
GERMANY
www.prologic-kist.de

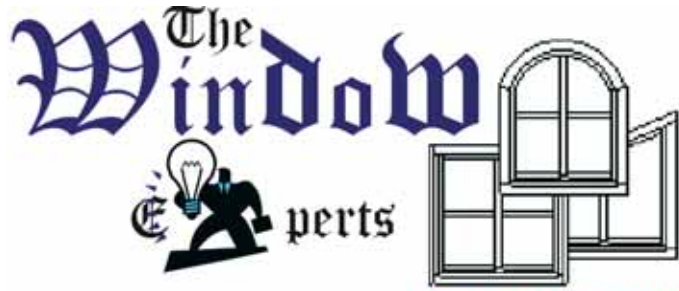

We open living spaces ...

Victoria House B&B
Guesthouse
15 Hurn Street

UK - BH23 6AA Christchurch

Date: 2006-03-06

DELIVERY NOTE



Windows - Doors - Accessories
of our own manufacturing

Process no.: DN-05/006-005 Customer phone: +44 23 / 928827-88 consisting of wood
Representative: David Wilborough Customer fax: +44 23 / 928827-99 and wood-aluminium
Insect protection solutions

Building project: Renovation and extension to the house

With reference to our order confirmation **OC-05/006-004** from **06.03.2006** we deliver the following items:

Pos. Tender	No.	Description of items	Drawing
1st phase of construction regular windows			
1 1.10.101	3 Pieces	Single-sash window T+T sash right, Affixed bar double-sided Width x Height: 900 mm x 1180 mm Profile system: IV 67 Wooden windows Metal fittings system: ROTO NT window hardware Timber type: Pine laminated wood Glass type: Climaplust N (Air) Float 4mm / 16 / Futur 4mm Surface coating: GORI 897.40310 Pine	Scale 1:100
2 1.10.102	1 Piece	Double-sash window 2 sashes: T+T sash left (1) and Turning sash right (2), Frame extension at the top, Affixed bar double-sided Width x Height: 1450 mm x 1280 mm Profile system: IV 67 Wooden windows Metal fittings system: ROTO NT window hardware Timber type: Pine laminated wood Glass type: Climaplust N (Air) Float 4mm / 16 / Futur 4mm Surface coating: GORI 897.40310 Pine	Scale 1:100
3 1.10.103	3 Pieces	Double-sash window With mullion, 2 sashes: Turning sash left (2) and T+T sash right (1), 1 x fixed glazing, Affixed bar double-sided Width x Height: 1750 mm x 1340 mm Profile system: IV 67 Wooden windows Metal fittings system: ROTO NT window hardware Timber type: Pine laminated wood Glass type: Climaplust N (Air) Float 4mm / 16 / Futur 4mm Surface coating: GORI 897.40310 Pine	Scale 1:100

Pos. Tender	No.	Description of items	Drawing
4 1.10.104	2 Pieces	Single-sash window Chamfered window, Turning sash left, Glass-dividing bar Width x Height: 900 mm x 1320 mm Profile system: IV 67 Wooden windows Metal fittings system: ROTO NT window hardware Timber type: Pine laminated wood Glass type: Climaplust N (Air) Float 4mm / 16 / Futur 4mm Surface coating: GORI 897.40310 Pine	Scale 1:100 
5 1.10.105	2 Pieces	Single-sash window Chamfered window, Turning sash right, Glass-dividing bar Width x Height: 900 mm x 1320 mm Profile system: IV 67 Wooden windows Metal fittings system: ROTO NT window hardware Timber type: Pine laminated wood Glass type: Climaplust N (Air) Float 4mm / 16 / Futur 4mm Surface coating: GORI 897.40310 Pine	Scale 1:100 
6 1.10.106	1 Piece	Single-sash window Circular window with transom, Tilted sash, 1 x fixed glazing, Affixed bar double-sided Width x Height: 1150 mm x 1150 mm Profile system: IV 67 Wooden windows Metal fittings system: ROTO NT window hardware Timber type: Pine laminated wood Glass type: Climaplust N (Air) Float 4mm / 16 / Futur 4mm Surface coating: GORI 897.40310 Pine	Scale 1:100 
		Exterior window sill Guntia ® 40/25 130mm (Bronze G214) For position 1, 3	
		Interior window sill Werzalit Exclusiv E 34/4 150mm White marble, For position 1, 3	

The above-mentioned positions were delivered and mounted:

Signature of site manager (with date): _____

Signature of customer (with date): _____

CAUTION: Please check all windows and additional items after receiving. We will only admit a claim within 2 days of delivery.

Please note:

Place of delivery, payment and jurisdiction is the business location of Leda Engineering Ltd. The ordered items remain to property of our company until complete payment. The delivery takes place according to our General Business Provisions. Additional agreements are exclusively valid in writing.

Rinderfelder Strasse 17
97270 Kist
GERMANY
www.prologic-kist.de



Mr. Walter C. Brown
49 Featherstone Street
LONDON
EC1Y 8SY
UNITED KINGDOM

INVOICE

Date: 2006-03-07

Process no.: IN-05/006-004
PO comm.: Victoria House B&B (1007)

Building project: Renovation and extension to the house

Due to our delivery to

Victoria House B&B
Guesthouse
15 Hurn Street

UK - BH23 6AA Christchurch

we invoice as follows:

32988,62 £ net amount
5278,18 £ value-added tax
38266,80 £ gross amount

Gross total in words: three - eight - two - six – six

Payable until 10.03.2006 with discount of 5,0 % (minus 1.913,34 £) or until 15.03.2006 with discount of 2,0 % (minus 765,34 £), otherwise until 06.04.2006 due net by bank transfer.

Please note:

Place of delivery, payment and jurisdiction is the business location of Leda Engineering Ltd. The ordered items remain to property of our company until complete payment.
The delivery took place according to our General Business Provisions.

Please transfer to the account stated below:

IBAN: DE85 7905 0000 0030 2097 46
SWIFT: BYLADEM1SWU
Bank name: Sparkasse Mainfranken
Bank code: 790 500 00
Bank account: 30 209 746

This letter does not require a signature.

INVOICE IN-05/006-004 to Mr. Walter C. Brown / Date of issue 07.03.2006

Page 2

Pos	Tender no.	No	Description of items	Unit price	Net total
1	1.10.101	3 Piece	Single-sash window Width x Height: 900 mm x 1180 mm Delivery: DN-05/006-005 of 06.03.2006	826,37 £	2.479,11 £
2	1.10.102	1 Piece	Double-sash window Width x Height: 1450 mm x 1280 mm Delivery: DN-05/006-005 of 06.03.2006	1.110,13 £	1.110,13 £
3	1.10.103	3 Piece	Double-sash window Width x Height: 1750 mm x 1340 mm Delivery: DN-05/006-005 of 06.03.2006	1.458,25 £	4.374,75 £
4	1.10.104	2 Piece	Single-sash window Width x Height: 900 mm x 1320 mm Delivery: DN-05/006-005 of 06.03.2006	1.098,36 £	2.196,72 £
5	1.10.105	2 Piece	Single-sash window Width x Height: 900 mm x 1320 mm Delivery: DN-05/006-005 of 06.03.2006	1.098,36 £	2.196,72 £
6	1.10.106	1 Piece	Single-sash window Width x Height: 1150 mm x 1150 mm Delivery: DN-05/006-005 of 06.03.2006	1.649,27 £	1.649,27 £
7	2.10.201	2 Piece	Lift-slide element Width x Height: 2800 mm x 2250 mm Delivery: DN-05/006-006 of 06.03.2006	1.996,02 £	3.992,04 £
8	2.10.202	1 Piece	Lift-slide element Width x Height: 4500 mm x 2300 mm Delivery: DN-05/006-006 of 06.03.2006	2.861,83 £	2.861,83 £
9	2.10.203	1 Piece	Fold-slide element Width x Height: 5500 mm x 2300 mm Delivery: DN-05/006-006 of 06.03.2006	2.934,50 £	2.934,50 £
10	2.10.204	1 Piece	Front door Width x Height: 1160 mm x 2078 mm Delivery: DN-05/006-006 of 06.03.2006	961,33 £	961,33 £
11	2.10.205	1 Piece	Window element Width x Height: 3600 mm x 2450 mm Delivery: DN-05/006-006 of 06.03.2006	5.376,23 £	5.376,23 £
12	2.10.206	1 Piece	Single-sash French door Width x Height: 1180 mm x 1980 mm Delivery: DN-05/006-006 of 06.03.2006	2.094,29 £	2.094,29 £
13	2.10.207	1 Piece	Double-sash French window Width x Height: 1000 mm x 1280 mm Delivery: DN-05/006-006 of 06.03.2006	1.691,49 £	1.691,49 £
14	2.10.208	6,50 m ²	Disassembling of window element Width x Height: x Delivery: DN-05/006-006 of 06.03.2006	12,80 £	83,20 £
15	2.10.209	6,50 m ²	Waste disposal (old windows) Width x Height: x Delivery: DN-05/006-006 of 06.03.2006	6,23 £	40,50 £
16	2.10.210	52,75 m	Joint caulking according to the state-of-the-art Width x Height: x Delivery: DN-05/006-006 of 06.03.2006	3,87 £	204,13 £
17	2.10.211	52,75 m	RAL-Assembling of window elements Width x Height: x Delivery: DN-05/006-006 of 06.03.2006	8,62 £	454,69 £

Sum of positions:	34.700,93 £
Less 5,00 % discount:	1.712,31 £
Net amount:	32.988,62 £
plus 16,0 % VAT:	5.278,18 £
Gross amount:	38.266,80 £

Windows - Doors - Accessories in wood and wood-aluminium

Outgoing invoice book 2006

13.3.2006 14:54

Page 1

ProLogic Computer GmbH EDP for window manufacturing

Document no.	Date	Customer	Commission	VAT	Gross	Cash discount	Settled payment	Note	Settled on	Bank	Outstanding
IN-05/006-004	07.03.2006	SMITH	Victoria House	7.626,36 EUR	55.291,13 EUR	2.764,56 EUR	30.000,00 EUR		08.03.2006	SPK 230	5.291,13 EUR
							20.000,00 EUR		11.03.2006	SPK 234	

Total invoiced amounts: 55.291,13 EUR

Total VAT: 7.626,36 EUR

Total settled payments: 50.000,00 EUR

Total cash discounts: 0,00 EUR

Total outstanding payments: 5.291,13 EUR



We open living spaces ...

Mr. Walter C. Brown
49 Featherstone Street
London
EC1Y 8SY
UNITED KINGDOM

Date: 2006-03-13

Re: 1st REMINDER

Your order of 2006-03-02, delivery on 2006-03-11

Dear Mr Smith,

On 2006-03-11 we delivered the positions which you ordered as requested. Unfortunately, your cheque has yet to arrive at the account given below at Sparkasse Mainfranken.

We therefor request that you make the payment of

5.291,13 EUR

by at the latest.

Enclosed please find a schedule of our bills receivable and of your payments settled till this day.

<i>Date</i>	<i>Document</i>	<i>Bills receivable</i>	<i>Settled payments</i>
2006-03-07	IN-05/006-004	55291,13 EUR	
2006-03-08			- 30000,00 EUR
2006-03-11			- 20000,00 EUR

If your payment overlaps our reminder, then regard this letter as meaningless.

Thank you for your understanding.

Yours sincerely

ProLogic Computer GmbH

EDP for window manufacturing

IBAN : DE85 7905 0000 0030 2097 46
SWIFT : BYLADEM1SWU
Bank name : Sparkasse Mainfranken
Bank code : 790 500 00
Bank account: 30 209 746

Precalculation sheet

7.3.2006 10:22

Page 1

Free-costing

ProLogic Computer GmbH EDP for window manufacturing

Process : QU-05/006-010
 Client : Brown, London
 PO commission : Victoria House B&B
 Position : Single-sash window
 Position number : 1
 Tender number : 1.10.101
 Unit : 3

Width : 900,0 mm
 Height : 1180,0 mm
 Area : 1,06 m²

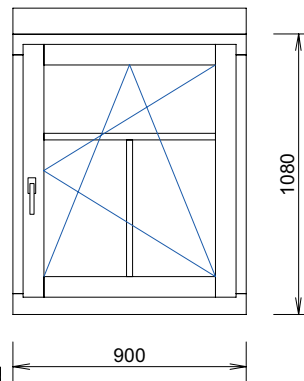

Price catalogue : Price catalogue 2006
 Profile system : IV 67 Wooden windows with standard

Direct material costs (including cut factors)

Climaplus N (Air) Float 4mm / 16 / Futur 4mm	0,60	m ²	83,75	£/m ²	50,25	£
Pine laminate 72/ 86	8,46	m	2,97	£/m	25,12	£
Pine laminate 72/105	0,99	m	5,37	£/m	5,32	£
GORI 411.64805 Natural-brown	0,67	ltr	6,54	£/ltr	4,38	£
GORI 897.40310 Pine	2,18	ltr	10,77	£/ltr	23,47	£
Sealing transparent	0,44	ml	2,73	£/ml	1,20	£
Deventer SV 103 brown	3,59	m	0,55	£/m	1,98	£
Deventer SV 125 brown	3,43	m	0,59	£/m	2,03	£
Drau 25/24 F bronze E6/G214	0,80	m	4,05	£/m	3,24	£
FP 6257 bronze E6/G214	0,71	m	3,15	£/m	2,24	£
EK 257/24 EPDM brown	2,00	piec	0,24	£/piece	0,48	£
EK 6257 EPDM brown	2,00	piec	0,24	£/piece	0,48	£
Werzalit Exclusiv E 34/4 150mm White marble	1,00	m	5,43	£/m	5,43	£
Guntia @ 40/25 130mm Bronze G214	1,00	m	6,44	£/m	6,44	£
Alu-edging 130mm grey	2,00	piec	1,54	£/piece	3,08	£
RotoLine handle R 01.2 newsilver	1,00	piec	1,18	£/piece	1,18	£
ROTO NT window hardware	28	Piec	2,07	£/Piece	57,96	£
Assembly block	13,00	piec	0,01	£/piece	0,13	£
Assembly foam	0,83	cart.	5,48	£/cart.	4,55	£
Bond timber	5,00	piec	1,35	£/piece	6,75	£
Caulking belt	0,21	pack	0,24	£/pack.	0,05	£
Caulking line	0,04	piec	4,75	£/piece	0,19	£
Cork filler	1,04	piec	0,83	£/piece	0,86	£
Masonry nail	5,00	piec	0,15	£/piece	0,75	£
Screws	21,00	piec	0,01	£/piece	0,21	£
Sealing	0,17	piec	0,24	£/piece	0,04	£
Wall tie	4,00	piec	0,19	£/piece	0,76	£
Total Direct material costs					208,57	£

Direct labour costs

	Hourly/Min. wa	Time		
01 Cutting	24,22 / 0,40	0:06 h	(6,3)	2,52
02 Planing	31,14 / 0,52	0:09 h	(8,9)	4,58
03 Profiling	65,75 / 1,10	0:25 h	(24,8)	27,21
07 Bar working	31,14 / 0,52	0:45 h	(45,0)	23,36
08 Frame press	24,22 / 0,40	0:12 h	(12,0)	4,84
10 Strips and rails	24,22 / 0,40	0:10 h	(10,0)	4,04
11 Surface working	44,99 / 0,75	0:57 h	(57,2)	42,69
12 Sash assembly	24,22 / 0,40	0:14 h	(14,3)	5,78
13 Glazing	20,76 / 0,35	0:15 h	(15,1)	5,21
14 Quality control	31,14 / 0,52	0:06 h	(6,0)	3,12
19 Weather boards / Door	24,22 / 0,40	0:13 h	(12,9)	5,18

Precalculation sheet

7.3.2006 10:22

Page 2

Free-costing

ProLogic Computer GmbH EDP for window manufacturing

Total Direct labour costs	3,54 h = 3:32 h	128,53 £
Direct material costs		208,57 £
Material overhead (8,00 %)		16,69 £
Material costs		225,26 £
Direct labour costs		128,53 £
Indirect labour costs (12,00 %)		15,42 £
Wage costs		143,95 £
Material and wage costs		369,21 £
Administration overhead (3,00 %)		11,08 £
Design overhead (2,00 %)		7,38 £
Pime costs		387,67 £
Profit (15,00 %)		58,15 £
Electrical tape drive (1 x)		92,05 £
Roller shutter built-in system (1 x)		285,15 £
calculated price		823,02 £
min. price (with 5,00 % profit): 784,25 £		

Material costing factors:	
Timbers	0,95
Costing factors:	
Price factor	1,00
Hourly wage factor	1,00

Precalculation sheet

7.3.2006 10:24

Page 1

Free-costing, Detail

ProLogic Computer GmbH EDP for window manufacturing

Process : QU-05/006-010
 Client : Brown, London
 PO commission : Victoria House B&B
 Position : Single-sash window
 Position number : 1
 Tender number : 1.10.101
 Unit : 3

Width : 900,0 mm
 Height : 1180,0 mm
 Area : 1,06 m²

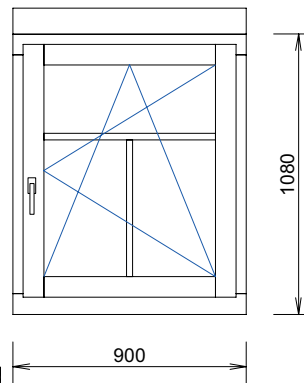

Price catalogue : Price catalogue 2006
 Profile system : IV 67 Wooden windows with standard

Direct material costs (including cut factors)

Climaplus N (Air) Float 4mm / 16 / Futur 4mm	0,60 m ²	83,75 £/m ²		50,25 £
Climaplus N (Air) Float 4mm / 16 / Futur 4mm	0,60 m ²	50,25 £	1	
- Glass measures: 690,0 mm x 870,0 mm				
- Calculated area: 0,600 m ²				
- Price determination: According to external dimensions (price matrix)				
- Price per: m ² prices				
- Price from list: 132,00				
- Supplier item group discount: 45,00 %				
Pine laminate 72/ 86	8,46 m	2,97 £/m		25,12 £
Pine laminate 72/ 86	1,01 m	3,00 £	FR B	
Pine laminate 72/ 86	1,01 m	3,00 £	FR T	
Pine laminate 72/ 86	1,20 m	3,56 £	FR L	
Pine laminate 72/ 86	1,20 m	3,56 £	FR R	
Pine laminate 72/ 86	0,93 m	2,75 £	SA B	
Pine laminate 72/ 86	0,93 m	2,75 £	SA T	
Pine laminate 72/ 86	1,09 m	3,25 £	SA L	
Pine laminate 72/ 86	1,09 m	3,25 £	SA R	
Pine laminate 72/105	0,99 m	5,37 £/m		5,32 £
Pine laminate 72/105	0,99 m	5,32 £	FEe T	
GORI 411.64805 Natural-brown	0,67 ltr	6,54 £/ltr		4,38 £
GORI 411.64805 Natural-brown	0,67 ltr	4,38 £		
GORI 897.40310 Pine	2,18 ltr	10,77 £/ltr		23,47 £
GORI 897.40310 Pine	2,18 ltr	23,47 £		
Sealing transparent	0,44 ml	2,73 £/ml		1,20 £
Sealing transparent	0,44 ml	1,20 £		
Deventer SV 103 brown	3,59 m	0,55 £/m		1,98 £
Deventer SV 103 brown	0,82 m	0,45 £	1	
Deventer SV 103 brown	0,82 m	0,45 £	1	
Deventer SV 103 brown	0,98 m	0,54 £	1	
Deventer SV 103 brown	0,98 m	0,54 £	1	
Deventer SV 125 brown	3,43 m	0,59 £/m		2,02 £
Deventer SV 125 brown	0,78 m	0,46 £	1	
Deventer SV 125 brown	0,78 m	0,46 £	1	
Deventer SV 125 brown	0,94 m	0,55 £	1	
Deventer SV 125 brown	0,94 m	0,55 £	1	
Drau 25/24 F bronze E6/G214	0,80 m	4,05 £/m		3,24 £
Drau 25/24 F bronze E6/G214	0,80 m	3,24 £	1	
FP 6257 bronze E6/G214	0,71 m	3,15 £/m		2,24 £
FP 6257 bronze E6/G214	0,71 m	2,24 £	1 SA	
EK 257/24 EPDM brown	2,00 piece	0,24 £/piece		0,48 £
EK 257/24 EPDM brown	2,00 piece	0,48 £		
EK 6257 EPDM brown	2,00 piece	0,24 £/piece		0,48 £

Precalculation sheet

7.3.2006 10:24

Page 2

Free-costing, Detail		ProLogic Computer GmbH EDP for window manufacturing			
EK 6257 EPDM brown	2,00 piece			0,48 £	
Werzalit Exclusiv E 34/4 150mm White marble	1,00 m	1,00 m		5,43 £/m	5,43 £
Werzalit Exclusiv E 34/4 150mm White marble	1,00 m			5,43 £	
Guntia @ 40/25 130mm Bronze G214	1,00 m	1,00 m		6,44 £/m	6,44 £
Guntia @ 40/25 130mm Bronze G214	1,00 m			6,44 £	
Alu-edging 130mm grey	2,00 piece	2,00 piece		1,54 £/piece	3,08 £
Alu-edging 130mm grey	2,00 piece			3,08 £	
RotoLine handle R 01.2 newsilver	1,00 piece	1,00 piece		1,18 £/piece	1,18 £
RotoLine handle R 01.2 newsilver	1,00 piece			1,18 £ 1 DS	
ROTO NT window hardware		28 Piece		2,07 £/Piece	57,96 £
Assembly block	13,00 piece	13,00 piece		0,01 £/piece	0,13 £
Assembly block	13,00 piece			0,13 £	
Assembly foam	0,83 cart.	0,83 cart.		5,48 £/cart.	4,55 £
Assembly foam	0,83 cart.			4,55 £	
Bond timber	5,00 piece	5,00 piece		1,35 £/piece	6,75 £
Bond timber	5,00 piece			6,75 £	
Caulking belt	0,21 pack.	0,21 pack		0,24 £/pack.	0,05 £
Caulking belt	0,21 pack.			0,05 £	
Caulking line	0,04 piece	0,04 piece		4,75 £/piece	0,19 £
Caulking line	0,04 piece			0,19 £	
Cork filler	1,04 piece	1,04 piece		0,83 £/piece	0,86 £
Cork filler	1,04 piece			0,86 £	
Masonry nail	5,00 piece	5,00 piece		0,15 £/piece	0,75 £
Masonry nail	5,00 piece			0,75 £	
Screws	21,00 piece	21,00 piece		0,01 £/piece	0,21 £
Screws	21,00 piece			0,21 £	
Sealing	0,17 piece	0,17 piece		0,24 £/piece	0,04 £
Sealing	0,17 piece			0,04 £	
Wall tie	4,00 piece	4,00 piece		0,19 £/piece	0,76 £
Wall tie	4,00 piece			0,76 £	
Total Direct material costs					208,56 £

Direct labour costs

Hourly/Min. wa

Time

		Hourly/Min. wa	Time		
01 Cutting	Parts sorting	24,22 / 0,40	0:02 h	(1,8)	0,72 £
Timber part : All except mouldings	1 Piece Part		0,20	FR B	
Timber part : All except mouldings	1 Piece Part		0,20	FR T	
Timber part : All except mouldings	1 Piece Part		0,20	FR L	
Timber part : All except mouldings	1 Piece Part		0,20	FR R	
Timber part : All except mouldings	1 Piece Part		0,20	FEe T	
Timber part : All except mouldings	1 Piece Part		0,20 1	SA B	
Timber part : All except mouldings	1 Piece Part		0,20 1	SA T	
Timber part : All except mouldings	1 Piece Part		0,20 1	SA L	
Timber part : All except mouldings	1 Piece Part		0,20 1	SA R	
01 Cutting	Timber selection	24,22 / 0,40	0:05 h	(4,5)	1,80 £
Timber part : All except mouldings	1 Piece Part		0,50	FR B	
Timber part : All except mouldings	1 Piece Part		0,50	FR T	
Timber part : All except mouldings	1 Piece Part		0,50	FR L	
Timber part : All except mouldings	1 Piece Part		0,50	FR R	
Timber part : All except mouldings	1 Piece Part		0,50	FEe T	
Timber part : All except mouldings	1 Piece Part		0,50 1	SA B	
Timber part : All except mouldings	1 Piece Part		0,50 1	SA T	
Timber part : All except mouldings	1 Piece Part		0,50 1	SA L	
Timber part : All except mouldings	1 Piece Part		0,50 1	SA R	
02 Planing	Four-sided planing	31,14 / 0,52	0:07 h	(7,1)	3,68 £
Timber part : All except mouldings	1 Piece Straight part		0,60	FR B	
Timber part : All except mouldings	0,92 m m straight		0,18	FR B	
Timber part : All except mouldings	0,92 m m straight		0,18	FR T	
Timber part : All except mouldings	1 Piece Straight part		0,60	FR T	
Timber part : All except mouldings	1,09 m m straight		0,22	FR L	
Timber part : All except mouldings	1 Piece Straight part		0,60	FR L	
Timber part : All except mouldings	1 Piece Straight part		0,60	FR R	

Precalculation sheet

7.3.2006 10:24

Page 4

Free-costing, Detail

ProLogic Computer GmbH EDP for window manufacturing

08 Frame press	Gluing frame		24,22 / 0,40	0:02 h	(2,0)		0,81 £
Timber frame : Only main frame		1 Piece	Frame		2,00		
10 Strips and rails	Longitudinal and face-side m.		24,22 / 0,40	0:10 h	(10,0)		4,04 £
Timber part : Shutter rail		1 Piece	Part		5,00	SR L	
Timber part : Shutter rail		1 Piece	Part		5,00	SR R	
11 Surface working	Finish coat spraying		44,99 / 0,75	0:17 h	(16,5)		12,32 £
Timber part : All		1 Piece	Straight part		1,50	FR B	
Timber part : All		1 Piece	Straight part		1,50	FR T	
Timber part : All		1 Piece	Straight part		1,50	FR L	
Timber part : All		1 Piece	Straight part		1,50	FR R	
Timber part : All		1 Piece	Straight part		1,50	FEe T	
Timber part : All		1 Piece	Straight part		1,50	SR L	
Timber part : All		1 Piece	Straight part		1,50	SR R	
Timber part : All		1 Piece	Straight part		1,50	SA B	
Timber part : All		1 Piece	Straight part		1,50	SA T	
Timber part : All		1 Piece	Straight part		1,50	SA L	
Timber part : All		1 Piece	Straight part		1,50	SA R	
11 Surface working	Intermediate grinding		44,99 / 0,75	0:24 h	(24,2)		18,16 £
Timber part : All		0,92 m	m straight		0,18	FR B	
Timber part : All		1 Piece	Straight part		2,00	FR B	
Timber part : All		0,92 m	m straight		0,18	FR T	
Timber part : All		1 Piece	Straight part		2,00	FR T	
Timber part : All		1,09 m	m straight		0,22	FR L	
Timber part : All		1 Piece	Straight part		2,00	FR L	
Timber part : All		1,09 m	m straight		0,22	FR R	
Timber part : All		1 Piece	Straight part		2,00	FR R	
Timber part : All		1 Piece	Straight part		2,00	FEe T	
Timber part : All		0,90 m	m straight		0,18	FEe T	
Timber part : All		1,18 m	m straight		0,24	SR L	
Timber part : All		1 Piece	Straight part		2,00	SR L	
Timber part : All		1,18 m	m straight		0,24	SR R	
Timber part : All		1 Piece	Straight part		2,00	SR R	
Timber part : All		1 Piece	Straight part		2,00	SA B	
Timber part : All		0,84 m	m straight		0,17	SA B	
Timber part : All		0,84 m	m straight		0,17	SA T	
Timber part : All		1 Piece	Straight part		2,00	SA T	
Timber part : All		1,00 m	m straight		0,20	SA L	
Timber part : All		1 Piece	Straight part		2,00	SA L	
Timber part : All		1,00 m	m straight		0,20	SA R	
Timber part : All		1 Piece	Straight part		2,00	SA R	
11 Surface working	Antistain dipping		44,99 / 0,75	0:06 h	(5,5)		4,07 £
Timber part : All		1 Piece	Straight part		0,50	FR B	
Timber part : All		1 Piece	Straight part		0,50	FR T	
Timber part : All		1 Piece	Straight part		0,50	FR L	
Timber part : All		1 Piece	Straight part		0,50	FR R	
Timber part : All		1 Piece	Straight part		0,50	FEe T	
Timber part : All		1 Piece	Straight part		0,50	SR L	
Timber part : All		1 Piece	Straight part		0,50	SR R	
Timber part : All		1 Piece	Straight part		0,50	SA B	
Timber part : All		1 Piece	Straight part		0,50	SA T	
Timber part : All		1 Piece	Straight part		0,50	SA L	
Timber part : All		1 Piece	Straight part		0,50	SA R	
11 Surface working	Base coat dipping		44,99 / 0,75	0:06 h	(5,5)		4,07 £
Timber part : All		1 Piece	Straight part		0,50	FR B	
Timber part : All		1 Piece	Straight part		0,50	FR T	
Timber part : All		1 Piece	Straight part		0,50	FR L	
Timber part : All		1 Piece	Straight part		0,50	FR R	
Timber part : All		1 Piece	Straight part		0,50	FEe T	
Timber part : All		1 Piece	Straight part		0,50	SR L	
Timber part : All		1 Piece	Straight part		0,50	SR R	
Timber part : All		1 Piece	Straight part		0,50	SA B	
Timber part : All		1 Piece	Straight part		0,50	SA T	
Timber part : All		1 Piece	Straight part		0,50	SA L	
Timber part : All		1 Piece	Straight part		0,50	SA R	
11 Surface working	Intermediate coat spraying		44,99 / 0,75	0:06 h	(5,5)		4,07 £
Timber part : All		1 Piece	Straight part		0,50	FR B	
Timber part : All		1 Piece	Straight part		0,50	FR T	
Timber part : All		1 Piece	Straight part		0,50	FR L	
Timber part : All		1 Piece	Straight part		0,50	FR R	

Precalculation sheet

7.3.2006 10:24

Page 5

Free-costing, Detail

ProLogic Computer GmbH EDP for window manufacturing

Timber part : All	1 Piece	Straight part		0,50	F E e T	
Timber part : All	1 Piece	Straight part		0,50	SR L	
Timber part : All	1 Piece	Straight part		0,50	SR R	
Timber part : All	1 Piece	Straight part		0,50	SA B	
Timber part : All	1 Piece	Straight part		0,50	SA T	
Timber part : All	1 Piece	Straight part		0,50	SA L	
Timber part : All	1 Piece	Straight part		0,50	SA R	
12 Sash assembly		Threading-in gasket		24,22 / 0,40	0:03 h	(2,8)
Deventer SV 103	0,82 m	m		0,33	1	
Deventer SV 103	0,82 m	m		0,33	1	
Deventer SV 103	0,98 m	m		0,39	1	
Deventer SV 103	0,98 m	m		0,39	1	
Deventer SV 125	0,78 m	m		0,31	1	
Deventer SV 125	0,78 m	m		0,31	1	
Deventer SV 125	0,94 m	m		0,37	1	
Deventer SV 125	0,94 m	m		0,37	1	
12 Sash assembly		Functional testing		24,22 / 0,40	0:01 h	(0,5)
T+T sash right	1 Piece	Sash		0,50	1	
12 Sash assembly		Drilling handle-hole		24,22 / 0,40	0:01 h	(1,0)
T+T sash right	1 Piece	Sash		1,00	1	
12 Sash assembly		Fixing components		24,22 / 0,40	0:10 h	(10,0)
T+T sash right [Up to 1500 x 1500 mm]		Sash dimension (width x height)		10,00	1	
13 Glazing		Fixing panes		20,76 / 0,35	0:12 h	(12,0)
Glazing : All [Up to 2,00m²]	0,58 m²	Area (size-dependent)		12,00	1	
13 Glazing		Sealing		20,76 / 0,35	0:03 h	(3,1)
Glazing : All	3,07 m	Perimeter (m)		3,07	1	
14 Quality control		Window frame and sash		31,14 / 0,52	0:06 h	(6,0)
Timber frame : All	1 Piece	Frame		3,00		
Timber frame : All	1 Piece	Frame		3,00	1	
19 Weather boards / Door		Profile cutting		24,22 / 0,40	0:03 h	(2,9)
FP 6257	0,67 m	m		1,34	1	SA
Drau 25/24 F	0,76 m	m		1,53	1	
19 Weather boards / Door		Mounting profile		24,22 / 0,40	0:08 h	(8,0)
FP 6257	1 Piece	Part		4,00	1	SA
Drau 25/24 F	1 Piece	Part		4,00	1	
19 Weather boards / Door		Mounting end caps		24,22 / 0,40	0:02 h	(2,0)
EK 6257 EPDM	2 Piece	Part		1,00		
EK 257/24 EPDM	2 Piece	Part		1,00		
Total Direct labour costs				3,54 h = 3:32 h		128,53 £
Direct material costs						208,56 £
Material overhead (8,00 %)						16,68 £
Material costs						225,24 £
Direct labour costs						128,53 £
Indirect labour costs (12,00 %)						15,42 £
Wage costs						143,95 £
Material and wage costs						369,19 £
Administration overhead (3,00 %)						11,08 £
Design overhead (2,00 %)						7,38 £
Pime costs						387,65 £
Profit (15,00 %)						58,15 £
Electrical tape drive (1 x)						92,05 £
Roller shutter built-in system (1 x)						285,15 £
calculated price						823,00 £
min. price (with 5,00 % profit): 784,23 £						
Material costing factors:						
Timbers	0,95					
Costing factors:						
Price factor	1,00					
Hourly wage factor	1,00					

Precalculation totals sheet

7.3.2006 10:27

Page 1

Free-costing

ProLogic Computer GmbH EDP for window manufacturing

Process :	QU-05/006-010	Number of positions:	15
Client :	Brown, London	Number of windows:	22
PO commission :	Victoria House B&B		
Profile system :	IV 67 Lifting-sliding elements (3) IV 67 Wooden windows (19)		

Direct material costs (including cut factors)

Glass

Climaplus N (Air) Float 4mm / 16 / Futur 4mm	28,07	m ²	132,79 £/m ²	3727,28 £
Climaplus N (Argon) Float 4mm / 16 / Futur 4mm	16,32	m ²	104,12 £/m ²	1699,24 £
				5426,52 £

Timbers

Oak laminate 72/ 86	79,07	m	8,36 £/m	661,02 £
Oak laminate 72/110	74,91	m	10,99 £/m	823,26 £
Oak laminate 72/145	5,64	m	14,48 £/m	81,64 £
Pine laminate 72/ 86	180,37	m	2,97 £/m	535,69 £
Pine laminate 72/105	7,37	m	5,37 £/m	39,59 £
Pine laminate 72/145	30,39	m	10,23 £/m	310,87 £
				2452,07 £

Balustrade / panel

Insulating mat. polyurethane	1,24	m ²	44,84 £/m ²	55,60 £
Panel type "Bremen" RAL coloured	1,00	m ²	436,02 £/m ²	436,02 £
Plywood panel +45°grooves RAL coloured	0,96	m ²	152,19 £/m ²	146,10 £
Plywood panel -45°grooves RAL coloured	0,96	m ²	151,71 £/m ²	145,64 £
Plywood panel 3-layers AW 100 RAL coloured	0,56	m ²	150,89 £/m ²	84,50 £
				867,86 £

Base coat types

GORI 411.64805 Natural-brown	18,88	ltr	6,51 £/ltr	122,89 £
GORI 411.90870 Pine	9,83	ltr	6,51 £/ltr	64,03 £
				186,92 £

Surface coatings

GORI 897.11310 RAL 9016	29,38	ltr	11,00 £/ltr	323,16 £
GORI 897.40310 Pine	58,28	ltr	10,76 £/ltr	627,08 £
GORI 897.60110 Teak	0,95	ltr	10,80 £/ltr	10,26 £
GORI RAL colour	2,95	ltr	11,00 £/ltr	32,45 £
				992,95 £

Sealings

Sealing transparent	16,22	ml	2,76 £/ml	44,73 £
Sealing white	9,25	ml	2,76 £/ml	25,55 £
				70,28 £

Gasket profiles

Deventer S 6600C brown	16,66	m	0,47 £/m	7,82 £
Deventer SV 103 brown	105,58	m	0,55 £/m	58,08 £
Deventer SV 125 brown	108,48	m	0,59 £/m	64,02 £
				129,92 £

Weatherboards

Drau 25/24 F bronze E6/G214	19,57	m	4,05 £/m	79,24 £
FP 6257 bronze E6/G214	19,99	m	3,18 £/m	63,57 £
Vils 25/24 bronze E6/G214	2,84	m	4,05 £/m	11,51 £
				154,32 £

Precalculation totals sheet

7.3.2006 10:27

Page 2

Free-costing

ProLogic Computer GmbH EDP for window manufacturing

Weatherboard end caps

EK 257/24 C EPDM brown	4,00	piece	0,24 £/piece	0,96 £
EK 257/24 EPDM brown	32,00	piece	0,24 £/piece	7,68 £
EK 6257 EPDM brown	76,00	piece	0,24 £/piece	18,24 £
				26,88 £

Doorsteps

BUG TBS 70 natural E6/EV1	1,28	m	7,73 £/m	9,89 £
G-U threshold P 1060 natural E6/EV1	12,63	m	12,79 £/m	161,60 £
				171,49 £

Doorstep end caps

Adaptor for G-U threshold RAL 7035 light grey	6,00	m	2,04 £/m	12,24 £
Adaptor for TBS 70 silver EV1	2,00	piece	1,28 £/piece	2,56 £
				14,80 £

Interior window sill profiles

Werzalit Exclusiv E 34/4 150mm White marble	15,09	m	5,43 £/m	81,92 £
---	-------	---	----------	---------

Exterior window sill profiles

Guntia ® 40/25 130mm Bronze G214	15,24	m	6,44 £/m	98,15 £
----------------------------------	-------	---	----------	---------

Exterior window sill edgings

Alu-edging 130mm grey	24,00	piece	1,54 £/piece	36,96 £
-----------------------	-------	-------	--------------	---------

Handles

Lever-handle DIRIGENT F1 - natural	4,00	piece	16,06 £/piece	64,24 £
RotoLine Flat-Handle R07.2 white	3,00	piece	6,33 £/piece	18,99 £
RotoLine handle R 01.2 newsilver	16,00	piece	1,18 £/piece	18,88 £
Security furniture ES1 turn-turn nature	1,00	set	31,14 £/set	31,14 £
				133,25 £

Metal fitting parts

Front door fittings	7	Piece	10,02 £/Piece	70,16 £
G-U Lift-Slide Serie 93x/95x	113	Piece	12,88 £/Piece	1454,93 £
ROTO NT window hardware	402	Piece	1,91 £/Piece	767,57 £
ROTO Patio 6080 Fold&Slide	49	Piece	8,58 £/Piece	420,35 £
				2713,01 £

General assembly material

Assembly block	440,00	piece	0,01 £/piece	4,40 £
Assembly foam	28,61	cart.	5,47 £/cart.	156,45 £
Bond timber	157,00	piece	1,35 £/piece	211,95 £
Caulking belt	7,15	pack	0,24 £/pack.	1,71 £
Caulking line	1,43	piece	4,51 £/piece	6,45 £
Cork filler	35,76	piece	0,83 £/piece	29,69 £
Masonry nail	157,00	piece	0,15 £/piece	23,55 £
Screws	724,00	piece	0,01 £/piece	7,24 £
Sealing	5,72	piece	0,24 £/piece	1,38 £
Wall tie	88,00	piece	0,19 £/piece	16,72 £
				459,54 £

Total Direct material costs

14016,84 £

Direct labour costs

		Hourly/Min. wa	Time	
01 Cutting	Parts sorting	24,22 / 0,40	0:48 h (47,8)	19,12 £
01 Cutting	Timber cutting	24,22 / 0,40	1:00 h (60,0)	24,24 £
01 Cutting	Timber selection	24,22 / 0,40	1:60 h (119,5)	48,04 £
02 Planing	Four-sided planing	31,14 / 0,52	3:08 h (187,9)	97,14 £
02 Planing	Preparation	31,14 / 0,52	0:48 h (47,8)	24,30 £
03 Profiling	Parts profiling	65,75 / 1,10	9:17 h (557,3)	610,56 £

Precalculation sheet

6.3.2006 15:00

Page 1

Windows price lists

ProLogic Computer GmbH EDP for window manufacturing

Process : QU-05/006-010
 Client : Brown, London (Victoria House B&B)
 Position : Single-sash window
 Position number : 1
 No. of units : 3

Width : 900,0 mm
 Height : 1180,0 mm
 Area : 1,06 m²

Price catalogue : : Price catalogue 2006
 Profile system : IV 67 Wooden windows with standard glazing profile

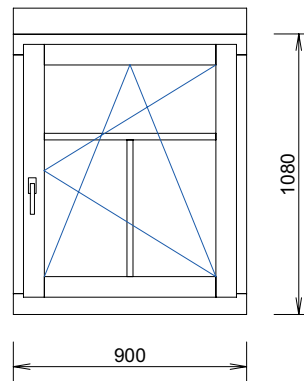

Type's price list

	Width	Height	Price
Type no. 1 (T&T window, single-sash)	1010,0	1260,0	275,00 EUR

Price list surcharges

	Calculation	Surcharge
Timber type Pine laminated wood	+ 3,0 %	8,25 EUR
Glass Climaplus N (Air) Float 4mm / 16 / Futur 4r	+ 2,0 %	5,50 EUR
Gasket scheme Double gasket at sash	+ 2,0 %	5,50 EUR

Material surcharges

	Calculation	Surcharge
Bars Affixed bar double-sided (Affixed bars)	18,00 EUR per Field (with cross)	54,00 EUR
Anodisation of weat bronze E6/G214	10,00 EUR per m Window width	9,00 EUR
Exterior window sill Guntia ® 40/25 130mm Bronze G214 (Gur	5,81 EUR per m Length	5,81 EUR
Interior window sill Werzalit Exclusiv E 34/4 150mm White ma	11,64 EUR per m Length	10,48 EUR
Shutter rails Wooden rails (groove 25mm)	5,50 EUR per m Window height	6,49 EUR
Assembly type New building	4,00 EUR per m ² Window area	4,25 EUR
Assembly type New building	15,00 EUR per Window	15,00 EUR
Longitudinal profile Windowsill rebate int./ext. (Window sill reb	2,00 EUR per m Length	2,00 EUR
Additional item Electrical tape drive		92,05 EUR
Additional item Roller shutter built-in system		285,15 EUR
Part type (timber) Exterior frame extension Top (Exterior fran	18,00 EUR per m Length (Width > 80 mm)	18,00 EUR
Weatherboard profil FP 6257	5,25 EUR per m Length	3,53 EUR
Sub-total window price		800,01 EUR

Window surcharges

	Calculation	Surcharge
Surface coating GORI 897.40310 Pine (wood colouring)	+ 3,5 %	28,00 EUR
Security level Security level 1	+ 4,0 %	32,00 EUR

calculated price

860,01 EUR

Material statistics

7.3.2006 13:19

Page 1

Timber/metal profiles - Number

ProLogic Computer GmbH EDP for window manufacturing

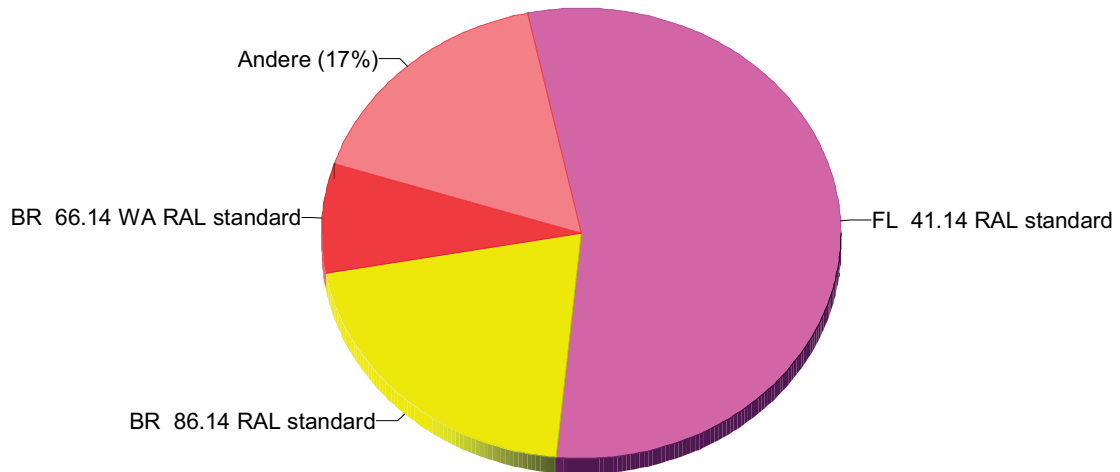

data	Number
BR 66.14 WA RAL standard	16
BR 86.14 IV RAL standard	6
BR 86.14 RAL standard	42
FL 41.14 RAL standard	112
K 110.12 RAL standard	6
SH 54.10 RAL standard	8
SH 120.10 RAL standard	4
SH 120.12 RAL standard	3
SL 66.9 RAL standard	7

Quantity evaluation

5.3.2006 14:07

Page 1

without cuttings

ProLogic Computer GmbH EDP for window manufacturing

Quantities for processes: Brown, London - QU-05/006-010

General items

Disassembling of window element		7 m ²
Waste disposal (old windows)		7 m ²

Timbers

Oak laminate 72/ 86	Wilhelm Rall oHG	71,88 m
Oak laminate 72/110	Wilhelm Rall oHG	68,10 m
Oak laminate 72/145	Wilhelm Rall oHG	5,13 m
Pine laminate 72/ 86	Wilhelm Rall oHG	164,03 m
Pine laminate 72/105	Wilhelm Rall oHG	4,00 m
Pine laminate 72/145	Wilhelm Rall oHG	27,63 m

Glass

Climaplus N (Air) Float 4mm / 16 / Futur 4mm	Cristal Max, Indústria de Vidros	27,01 m ²
Climaplus N (Argon) Float 4mm / 16 / Futur 4mm	Cristal Max, Indústria de Vidros	15,48 m ²

Weatherboards

Drau 25/24 F bronze E6/G214	VBH Deutschland GmbH	18,64 m
FP 6257 bronze E6/G214	VBH Deutschland GmbH	19,04 m
Vils 25/24 bronze E6/G214	VBH Deutschland GmbH	2,71 m

Doorsteps

BUG TBS 70 natural E6/EV1	VBH Deutschland GmbH	1,16 m
G-U threshold P 1060 natural E6/EV1	Gretsch-Unitas GmbH	10,10 m

Interior window sill profiles

Werzalit Exclusiv E 34/4 150mm White marble	VBH Deutschland GmbH	14,15 m
---	----------------------	---------

Exterior window sill profiles

Guntia ® 40/25 130mm Bronze G214	PRO-ALU Systemhandel	14,15 m
----------------------------------	----------------------	---------

Handles

Lever-handle DIRIGENT F1 - natural	Gretsch-Unitas GmbH	4 piece
RotoLine Flat-Handle R07.2 white	Roto Frank AG	3 piece
RotoLine handle R 01.2 newsilver	Roto Frank AG	16 piece
Security furniture ES1 turn-turn nature	VBH Deutschland GmbH	1 set

Gasket profiles

Deventer S 6600C brown	VBH Deutschland GmbH	16,66 m
Deventer SV 103 brown	VBH Deutschland GmbH	105,58 m
Deventer SV 125 brown	VBH Deutschland GmbH	108,48 m

Base coat types

GORI 411.64805 Natural-brown	Frankenberg e.K.	18,40 ltr
GORI 411.90870 Pine	Frankenberg e.K.	9,83 ltr

Surface coatings

GORI 897.11310 RAL 9016	Frankenberg e.K.	29,38 ltr
GORI 897.40310 Pine	Frankenberg e.K.	56,73 ltr
GORI 897.60110 Teak	Frankenberg e.K.	0,95 ltr
GORI RAL colour	Frankenberg e.K.	2,95 ltr

Quantity evaluation

5.3.2006 14:07

Page 2

without cuttings

ProLogic Computer GmbH EDP for window manufacturing

Sealings

Sealing transparent	Akzo Nobel Deco GmbH	16,22 ml
Sealing white	Akzo Nobel Deco GmbH	9,25 ml

Additional item

Electrical tape drive	Karl Achenbach GmbH & Co. K	17 piece
Roller shutter built-in system	Karl Achenbach GmbH & Co. K	17 piece
Strip 47 30x30mm		3 piece
Strip 48 30x30mm		3 piece

General assembly material

Assembly block	Adolf Würth GmbH & Co.KG	437 piece
Assembly foam	Adolf Würth GmbH & Co.KG	28,49 cart.
Bond timber	Adolf Würth GmbH & Co.KG	157 piece
Caulking belt	Adolf Würth GmbH & Co.KG	7,12 pack.
Caulking line	Adolf Würth GmbH & Co.KG	1,42 piece
Cork filler	Adolf Würth GmbH & Co.KG	35,61 piece
Masonry nail	Adolf Würth GmbH & Co.KG	157 piece
Screws	Adolf Würth GmbH & Co.KG	721 piece
Sealing	Adolf Würth GmbH & Co.KG	5,70 piece
Wall tie	Adolf Würth GmbH & Co.KG	88 Piece

Weatherboard end caps

EK 257/24 C EPDM brown	VBH Deutschland GmbH	4 piece
EK 257/24 EPDM brown	VBH Deutschland GmbH	32 piece
EK 6257 EPDM brown	VBH Deutschland GmbH	76 piece

Doorstep end caps

Adaptor for G-U threshold RAL 7035 light grey	Gretsch-Unitas GmbH	6 m
Adaptor for TBS 70 silver EV1	Meesenburg Fachgroßhandel C	2 piece

Exterior window sill edgings

Alu-edging 130mm grey	PRO-ALU Systemhandel	24 piece
-----------------------	----------------------	----------

Balustrade / panel

Insulating mat. polyurethane	Wilhelm Rall oHG	
Panel type "Bremen" RAL coloured	Wilhelm Rall oHG	
Plywood panel +45°grooves RAL coloured	Wilhelm Rall oHG	
Plywood panel -45°grooves RAL coloured	Wilhelm Rall oHG	
Plywood panel 3-layers AW 100 RAL coloured	Wilhelm Rall oHG	

ProLogic Europe



ProLogic Computer GmbH
Rinderfelder Straße 17
D-97270 Kist
Tel. +49 9306 9096-0
Fax +49 9306 9096-36
e-mail: info@prologic-kist.de
www.prologic-kist.de

Ansprechpartner Deutschland
Herr Reuter

Ansprechpartner Ausland
Herr Bullmann



Roland Gerling
Herr Gerling
Lengfurter Str. 48
D-97892 Kreuzwertheim
Tel. +49 9342 9297-0
Fax +49 9342 9297-20
e-mail: Gerling.Software@t-online.de
www.roland-gerling.de



m.p.network GmbH
Herr Lochmann
Wyssmattstraße 7a
CH-6010 Kriens
Tel. +41 41 312 10 30
Fax +41 41 312 10 32
e-mail: info@mpnetwork.ch
www.mpnetwork.de



ProLogic Handelsges.mmbH
Herr Fahrafellner
Hohenegger Straße 9B
A-3386 Hafnerbach
Tel. +43 2749 5376
Fax +43 2749 5376-13
e-mail: prologic@aon.at
www.fenoffice.at



Greenteam Kft.
Herr Alpár
Varasd u. 16.
H-9700 Szombathely
Tel. +36 94 510 830
Fax +36 94 315 215
e-mail: greenteam@axelero.hu



Jan Megier
Maschinen & Anlagen e.K.
Herr Megier
Hansestraße 74
D-38112 Braunschweig
Tel. +49 531 2508664
Fax +49 531 2508696
e-mail: info@megier.biz
www.megier.biz



Rudolf Deye GmbH & Co.KG
Herr Allersmeier
Kurzekampstr. 17A
D-38104 Braunschweig
Tel. +49 531 46688
Fax +49 531 46693
e-mail: deye-maschinen@t-online.de
www.deye-maschinen.com

features and modules of FenOffice	Standard	Professional	Enterprise
	S	P	E
ProAdmin			
address administration	●	●	●
extended address administration	-	●	●
list-printings over report generator	-	●	●
material administration	●	●	●
supplier administration	-	●	●
extended fictitious articles	-	●	●
discount management	-	●	●
selling price calculation (special prices)	-	●	●
administration of auxiliary documents	-	●	●
target-times print	-	●	●
lists with report generator	-	●	●
project management	●	●	●
project characteristics	-	●	●
completion of standard procedures	●	●	●
extended procedure completion	-	●	●
process export to Microsoft Word	●	●	●
process printing over report-generator	-	●	●
direct part-list printing	●	●	●
sum positions	●	●	●
user administration	-	○	●
ability to clientele processing	-	-	●
salesman - referred project filters	-	-	●
server dongle	-	○	●
data base on Microsoft SQL server	-	-	○
application over terminal server	-	○	●
ERP / PPS link-up	-	-	○
ProDesign			
single materials type, including free-parts lists	●	-	-
further materials types including free-parts lists	○	-	-
all materials	-	○	○
free-parts lists	-	○	○
free label-design	○	○	○
administration of target-times	-	●	●
administration of fitting sets	○	●	●
machine controlling	-	○	○
optional auxiliary modules	○	○	○
contained licences	1	1	5
licence packages /-steps	1	1	5

● available ○ optional - not available

ProAdmin - Office management
addresses, materials, projects, business processes
order and stock control
printer plug-in (HTML, PDF, RTF)
debtors, lenders, dunning
contact management
material statistics
user management
duplicate address check
dealer interface
manufacturer interface
repair glazing
time management
post calculation

ProView - facade design
project preview
window catalogue
door catalogue
accessories catalogue

ProService - software support
service contract
update contract
hotline service
remote maintenance
on site service
in-house training
further development
individual development

ProDesign - window construction
element combining
U-Wert calculation
pre calculation
window price lists
window catalogue
basic production lists
production lists for wood, PVC, wood-aluminum
stormproofing program
cut optimization for rods
inch- / foot-capability

online data transfer
Weinig Nexus UC6, UC10, UT10, Univar, UC-Matic
Weinig seriell UC10, UT10, UC-Matic
SCM Method K, Super
SCM Windor 50, 20, 60
SCM System 10
Gubisch ESTH, CW3, CW6
Stegherr FDE, DD
Koch BL-51 NC
Koch Windor
Koch Windor / UC
IMA CNC
Homag BOF
Harbs
Haffner FLS
Haffner saws
Ferranti saws
Schüco saws
Elumatec saws
Rapid saws
Roob OptiCut



**software
for
window
construction**

ProLogic Computer GmbH
Rinderfelder Straße 17
D-97270 Kist
Germany

Fon: +49 9306 9096 0
Fax: +49 9306 9096 36
mail: info@ProLogic-Kist.de
internet: www.ProLogic-Kist.de